

AC-DC Converter

**POWER
SOLVE**

PEK3000 Series 3000W Active PFC Programmable Single Output

www.powersolve.com.tw

Features

- Universal AC Input / Full Range
- Programmable Output Voltage (0%-105%)
- Programmable Output Current (0%-105%)
- Constant Current Limit
- Intelligent LED Indicators
- Forced current sharing for parallel operation
- Power OK signal (Power good, logic low)
- Remote ON/OFF, Remote Sense function
- OVP, OLP, OTP, SCP, Fan Failure Protections
- Selectable +5V/0.5A or +9V/0.3A Auxiliary Output
- Global control via RS232
- Remote Setting Multiple PSU's via RS232, RS485 & I²C



Electrical Specification

Input Voltage	90-264VAC full range, 47-63Hz / 127-370VDC. (refer to derating curve for low AC input derating)
Power Factor	0.95 at 230VAC / 0.98 at 115VAC at full load
AC Input Current (typ.)	19.7A at 115VAC (2000W) / 14.5A at 230VAC (3000W)
Inrush Current	33A at 115VAC / 65A at 230VAC
Leakage Current	<2.5mA at 240VAC
Output Voltage	See Table
Output Current	See Table
Voltage Tolerance	±2%
Voltage Adjust Range	±5.0% typical adjustment by potentiometer
Overload Protection	>105% of rated output power. Protection type: Constant current limiting
Overvoltage Protection	Variable OVP, 120% ±7% Vout. Output latches off, recycle AC input to recover or inhibit (refer to VCI VS OVP curve)
Over Temperature Protection	Shuts down output, recovers automatically (85°C ±5°C detect on heatsink on primary & secondary side)
Auxiliary Power	+5V/0.5A or +9V/0.3A auxiliary output selected by user
Remote ON/OFF Control	External switch or NPN transistor to turn on/off
Power OK Signal	Open drain signal low when PSU turns on. Max. sink current 20mA, max drain voltage 40V
Output Voltage Programming	Adjustment of output voltage between 0-105% of rated output
Output Current Programming	Adjustment of output current between 0-105% of rated output
Operating Temperature Range	-25°C to +60°C. Above 50°C, derate linearly to 50% load at 60°C
Operating Humidity	20-90% RH non-condensing
Storage Temperature Range	-40°C to +85°C
Storage Humidity	10-95% RH non-condensing
Temperature Coefficient	±0.02%/°C (0-50°C)
Vibration	Compliance to IEC68-2-6, IEC68-2-64. 10-500Hz, 5G 10 mins / 1 cycle, period for 60 mins. along X, Y, Z axes
Safety Standards	Meet UL60950-1, EN60950-1
Withstand Voltage	I/P-O/P: 3KVAC, I/P-FG: 1.5KVAC, O/P-FG: 0.5KVAC
Isolation Resistance	I/P-O/P, I/P-FG, O/P-FG: 100MΩ / 500VDC
EMI Conduction & Radiation	Certified to EN55022, EN61204-3, EN61000-6-3
Harmonic Current	Certified to EN61000-3-2, EN61000-3-3
EMS Immunity	Certified to EN55024, EN61204-3, EN61000-6-1, EN61000-4-2, -3, -4, -5, -6, -8, -11
Cooling	Internal fan controlled by power rating & temperature, allow 50mm clearance at each end for airflow
Dimensions	280(L) x 170(W) x 63.5(H) mm
Weight	3.8Kg

Notes:

1. All parameters NOT specifically mentioned are measured at 230VAC input, rated load and 25°C ambient temperature
2. Ripple and noise are measured at 20MHz bandwidth by using a 12" twisted pair wire terminated with a 0.1μF ceramic & 47μF electrolytic capacitors across the output
3. Tolerance includes set up tolerance, line regulation and load regulation
4. Derating is required at low input voltages. Refer to derating curve
5. When parallel connected, only one unit may operate if the total output load is less than 5% of rated load
6. The power supply is considered a component which will be installed into a final equipment. The final equipment must be re-confirmed that it still meets EMC Directives
7. Withstand Voltage test is done without enclosure

Email: sales@powersolve.com.tw

AC-DC Converter



www.powersolve.com.tw

Output Voltage and Current Ratings

MODEL	OUTPUT VOLTAGE	MAX OUTPUT CURRENT	RIPPLE & NOISE	LINE REG.	LOAD REG.	POWER Max.	EFF.
PEK3000-12	12V	200A	150mV p-p	±1%	±1%	2400W	88%
PEK3000-15	15V	160A	150mV p-p	±1%	±1%	2400W	89%
PEK3000-24	24V	125A	200mV p-p	±1%	±1%	3000W	91%
PEK3000-30	30V	100A	200mV p-p	±1%	±1%	3000W	91%
PEK3000-36	36V	83.5A	200mV p-p	±1%	±1%	3006W	92%
PEK3000-48	48V	62.5A	200mV p-p	±1%	±1%	3000W	92%
PEK3000-60	60V	50A	300mV p-p	±1%	±1%	3000W	93%

Mechanical & Connection Details

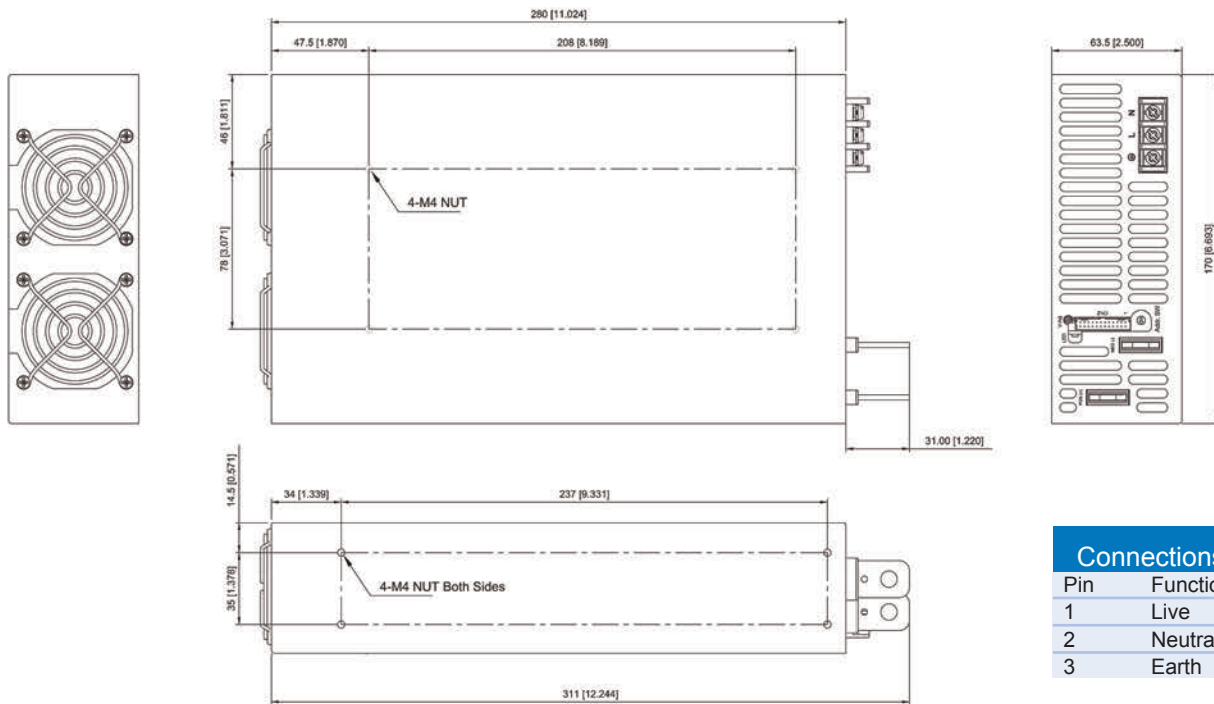

Connections

Pin	Function
1	Live
2	Neutral
3	Earth

Function Description of CN2, Control Connector

Pin No.	Function	Description	Mating Housing	Terminal
1	N.C.	For RS232 Receiver Function		
2	N.C.	For RS232 Transmission Function		
3, 7, 14	AUX	+5V/0.5A or +9V/0.3A Auxiliary power		
4, 8, 10, 12, 16, 20	GND	Ground		
5	SCL	Serial Data used in the I2C interface		
6	SDA	Serial Data used in the I2C interface		
9	VCI	V Program	JST	JST
11	ACI	I Program		
13	EN+	Inhibit ON/OFF +	PHDR-24VS	SPHD-002T-P0.5
15	EN-	Inhibit ON/OFF -		
17	PAR	Parallel operation current share	or equivalent	or equivalent
18	VSET	Aux Output Set		
19	POK	Power OK		
21	VS-	Remote Sense -		
22	VO-	Negative Output Voltage		
23	VS+	Remote Sense +		
24	VO+	Positive Output Voltage		

AC-DC Converter



www.powersolve.com.tw

LED Status

LED Colour	LED Signal	Status
Green LED	Solid	Power OK (Local mode)
Orange LED	Solid	Power OK (Remote mode)
Green LED	Slow Blink	Power Standby
Red LED	Fast Blink	Over Voltage Protection (OVP)
	Solid	Over Load Protection (OLP)
	Slow Blink	Over Temperature Protection (OTP)
	Intermittent Blink	Fan Failure
	Interlace Blink	Power Failure

Local mode: Use ACI / VCI to control output current and voltage
 Remote mode: Use RS232 or I²C command to control output current and voltage

De-rating Curve

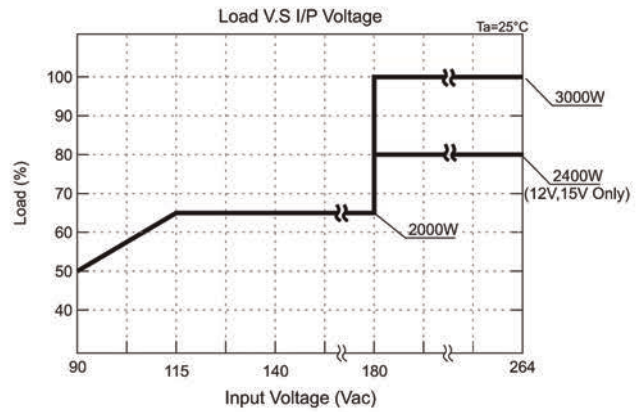
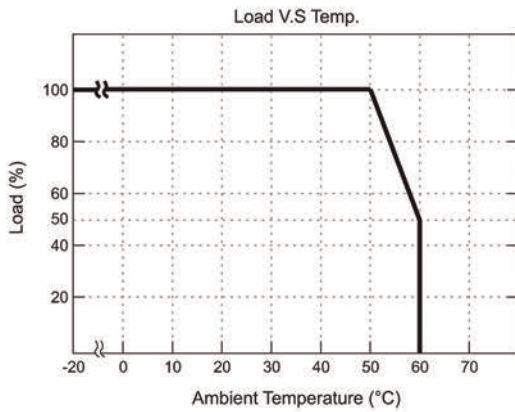

Control Voltage Input vs OVP Curve

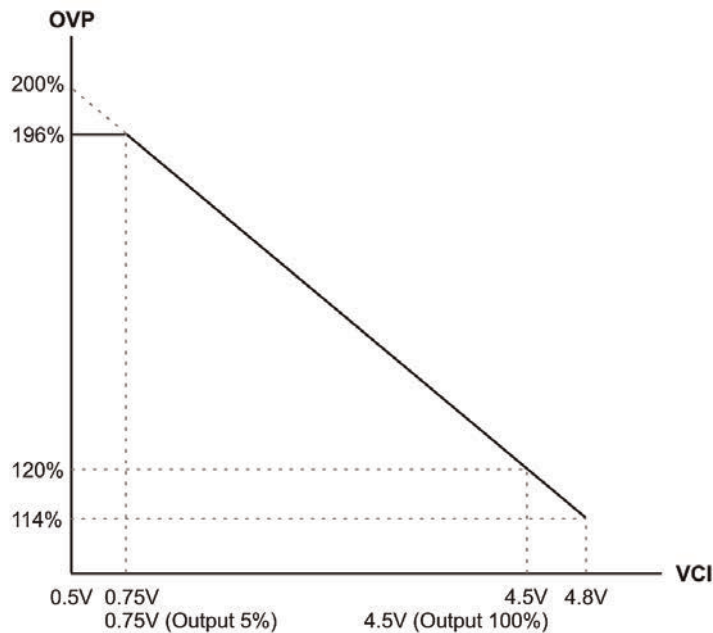

AC-DC Converter



www.powersolve.com.tw

Programming Input

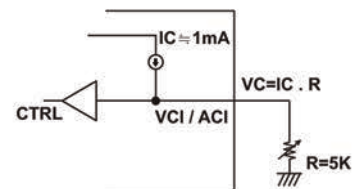
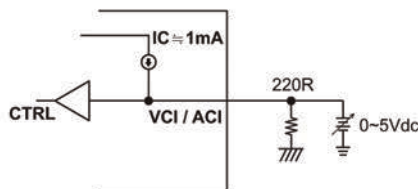
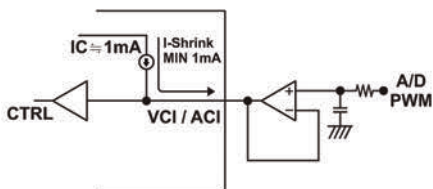
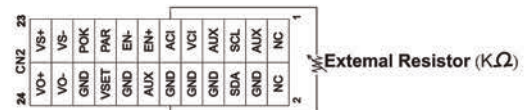
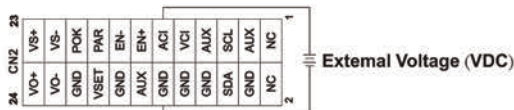
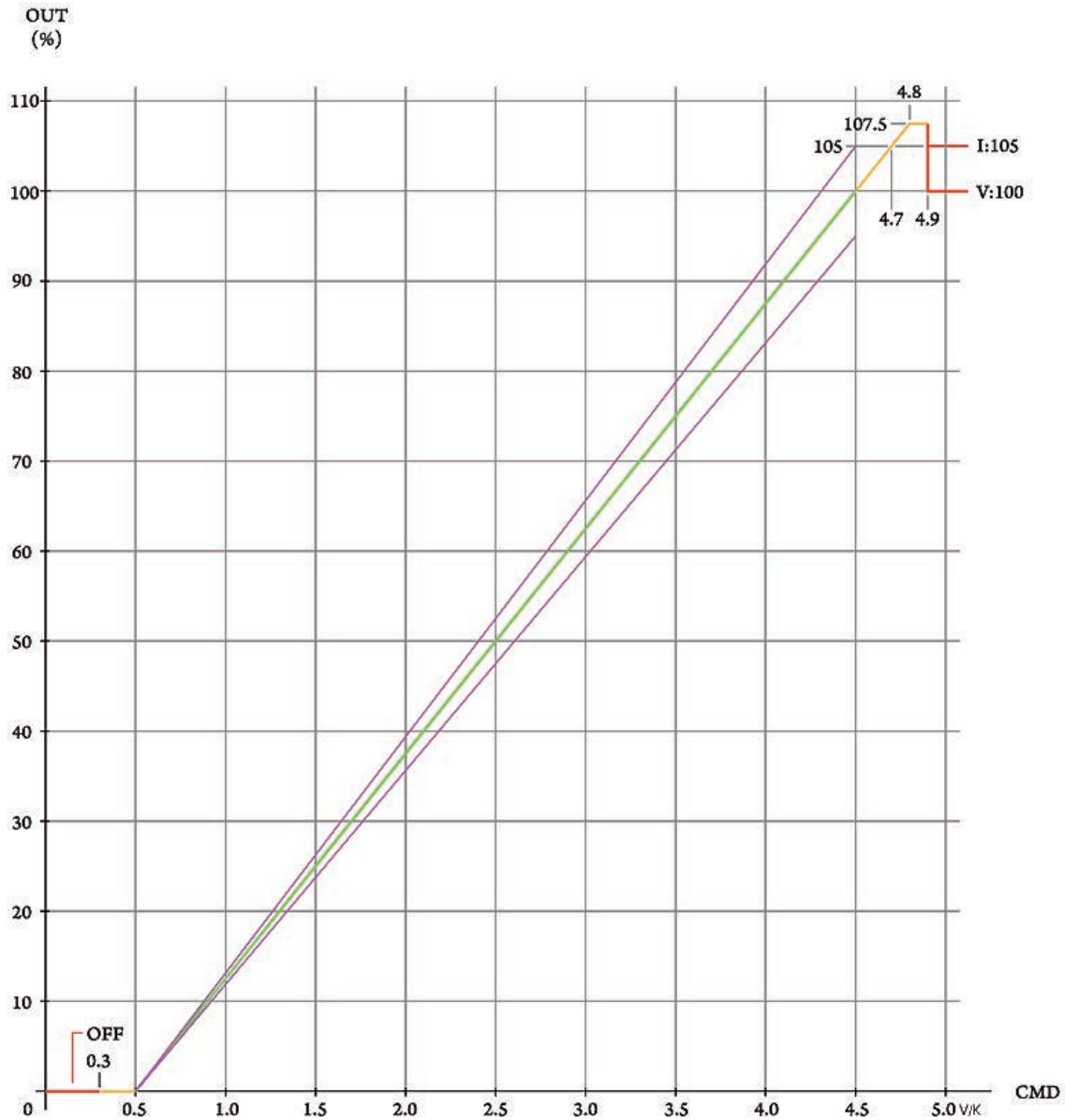

AC-DC Converter



www.powersolve.com.tw

Remote ON/OFF

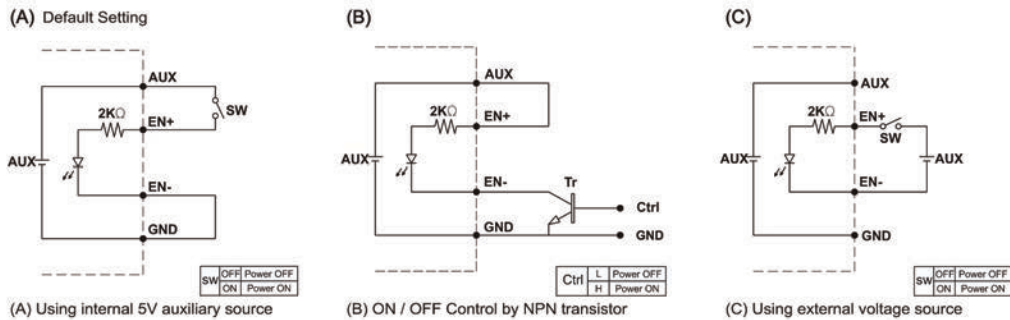

Power OK Signal

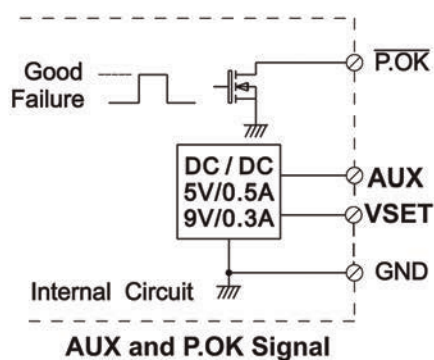

*Place an additional capacitor to have a better performance of auxiliary power operation.

*The grounding of "AUX" power should be connected to "GND" port. If "V-" is connected as Grounding, make sure to short the GND and V- ports.

VSET	Open	5V	(Default Setting)
	Short To GND	9V	

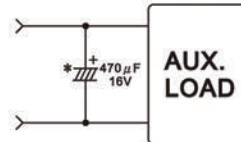

Functions

1. Remote Sense

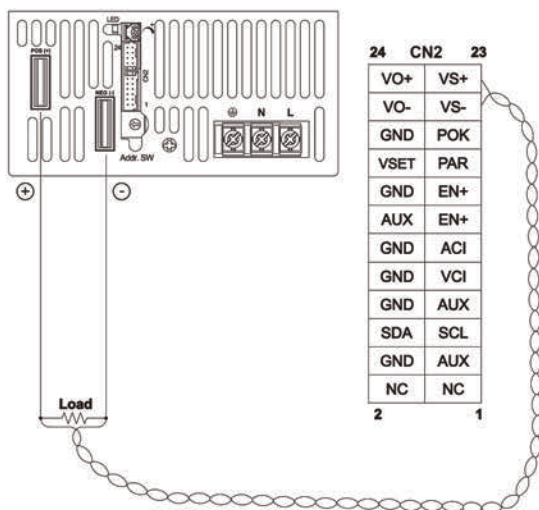

2. Local Sense (Default setting)

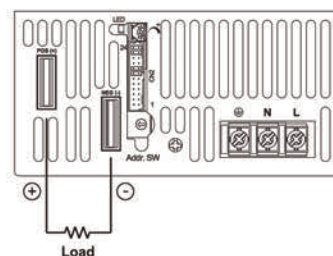

CN2	
24	23
VO+	VS+
VO-	VS-
GND	POK
VSET	PAR
GND	EN+
AUX	EN+
GND	ACI
GND	VCI
GND	AUX
SDA	SCL
GND	AUX
NC	NC
2	1

AC-DC Converter



www.powersolve.com.tw

3. Current Sharing with Remote Sensing

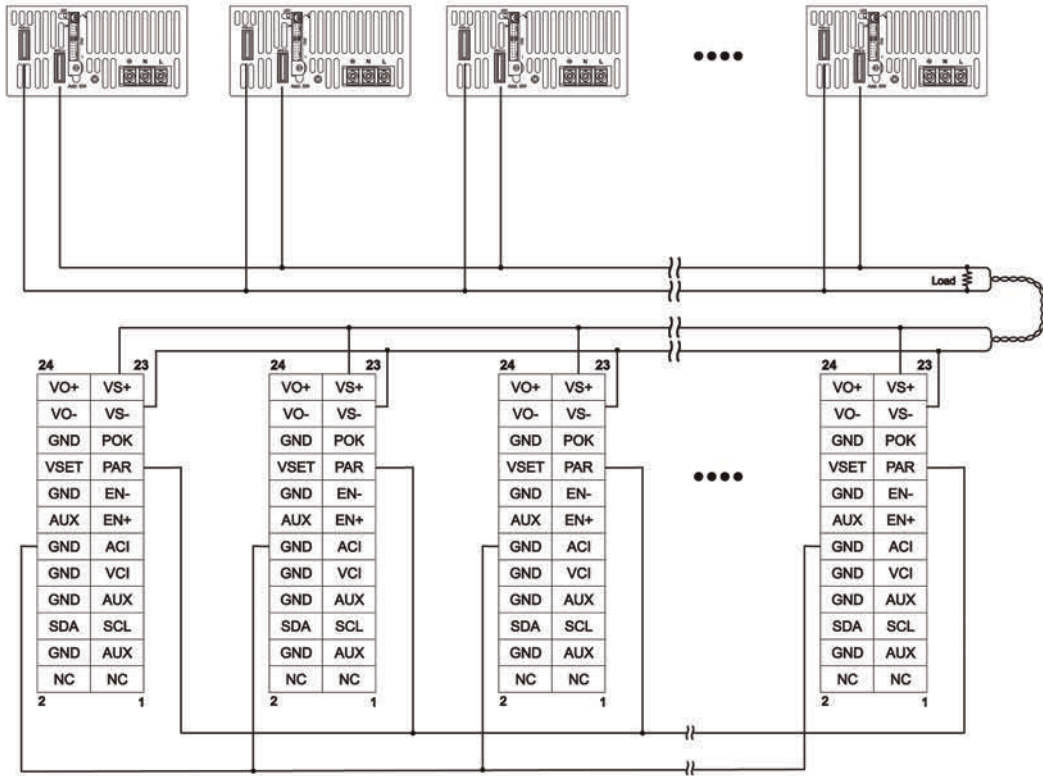

4. Current Sharing with Local Sensing

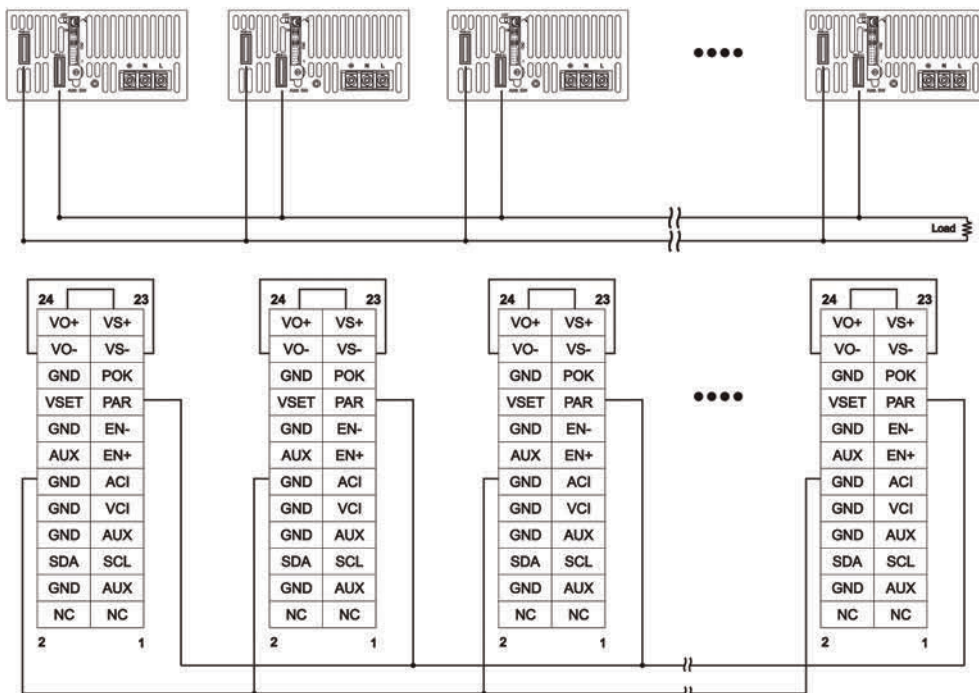

AC-DC Converter

**POWER
SOLVE**

www.powersolve.com.tw

Installation Instructions

1. Mounting Directions

1-1 Recommended standard mounting methods:

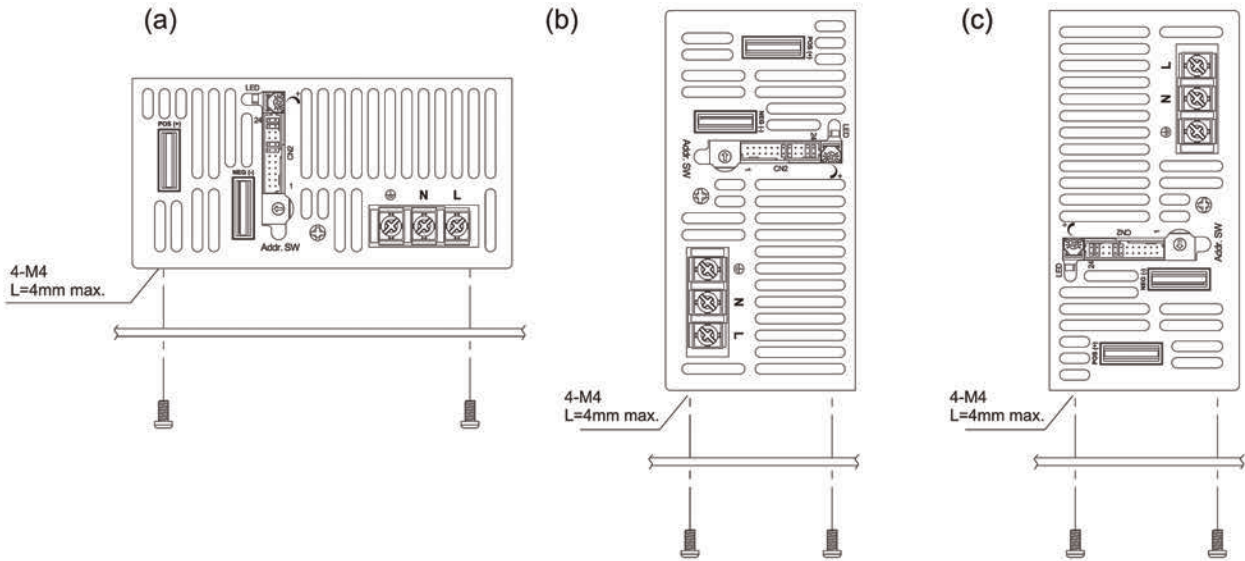

2. Mounting Method

2-1 There are ventilating holes on the front and back side panels, do not obstruct; allow 50mm at least for air flow.

2-2 The Maximum allowable penetration of screw is 4mm. Incomplete threading should not be penetrated.

2-3 Recommended the torque of mounting screw:
M4 screw: $1.27\text{N} \cdot \text{m}$ ($13.0\text{kgf} \cdot \text{cm}$)

