

**100W** Convection cooled

AC-DC power supplies

The PGW100 series of 100W external wall mount AC-DC power supplies conform to the Power Delivery protocol with outputs from 5V to 20V auto-selected based on the system's charging requirement. Their Class II construction, gasketed design and reinforced isolation provide enhanced safety in medical devices and household appliances. The PGW100 also offers interchangeable US, UK, EU, AU and CN mains connectors for global compatibility.

Worldwide medical and ITE safety agency approvals, low leakage currents, compact Gallium-Nitride (GaN) based design, wide 80-264VAC input for universal use, energy efficiency level VI (level VII ready) and support for multiple fast charging protocols, makes the PGW100 ideal for a wide range of industrial and BF-rated medical applications.



## Features

- ▶ Output voltages from 5V to 20VDC
- ▶ Universal, single phase input: 80 to 264VAC
- ▶ Energy efficiency level VI (level VII ready) and EU2019/1782
- ▶ Meets USB PD 3.0 & QC4.0+ fast charging protocol
- ▶ Medical, home healthcare & ITE safety agency approvals
- ▶ IP22 environmental rating
- ▶ Low earth leakage current
- ▶ <0.15W standby power
- ▶ Class B conducted & radiated emissions
- ▶ 0 to +60°C operation
- ▶ 3 year warranty

## Applications

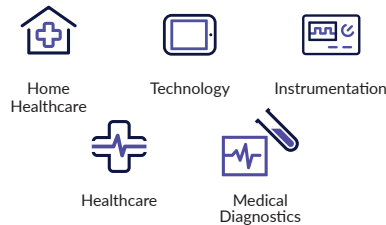

## Dimensions

97.0 x 57.0 x 34mm (3.82" x 2.24" x 1.34")

## Models & ratings

Model number <sup>(1)</sup>	Output voltage Auto-selected by load	Output current	Output power	Total regulation <sup>(2)</sup>	Efficiency <sup>(3)</sup>
PGW100PS20-I-BB	5.0V	3.0A	15.0W	±5%	82.0%
	9.0V	3.0A	26.0W		86.8%
	12.0V	3.0A	36.0W		87.5%
	15.0V	3.0A	45.0W		88.0%
	20.0V	5.0A	100.0W		89.0%

### Notes:

1. Model number is for body with USB-C connector in case. AC plugs should be ordered separately, see pages 5 & 6 for order codes. To order body and 5 AC plugs, use order code PGW100PS20-IP-BB.
2. Total regulation includes initial set accuracy, line and load regulation.
3. Typical average value measured at 25%, 50%, 75% and 100% at 115VAC & 230VAC.

## Input

Characteristic	Minimum	Typical	Maximum	Units	Notes & conditions
Input voltage	80		264	VAC	Derate output linearly from 100% at 90VAC to 90% at 80VAC
Input frequency	47		63	Hz	
Power factor	0.9				230VAC full load, complies with EN61000-3-2 for Class A
Input current			1.8	A	100VAC full load.
Inrush current			150	A	264VAC, cold start +25°C
No load input power			0.15	W	
Input protection	T4.0A/250V Internal fuse fitted in line and neutral				
LED indicator	LED (on case) status mode - standby (Amber), normal operation (Green), and fault (flashing Amber)				

## Output

Characteristic	Minimum	Typical	Maximum	Units	Notes & conditions
Output voltage	5		20	VDC	5, 9, 12, 15, 20VDC. Auto selected by load
Minimum load	0			A	No minimum load required
Start up delay			3	s	
Start up rise time		200		ms	115VAC
Hold up time	10			ms	Full load and 115VAC
Total regulation			±5		See models & ratings table
Transient response			10	%	Recovery within 1% in less than 5ms for a 60% (20% - 80% - 20%) load step and 0.5A/μs slew rate
Ripple & noise			200	mV/pk-pk	20MHz bandwidth and 10μF electrolytic at +25°C in parallel with 0.1μF ceramic capacitor at +25°C
Overshoot			10	%	Turn on & turn off
Overload protection	110		150	%	
Overvoltage protection	110		140	%	Auto recovery
Temperature coefficient			0.2	%/°C	
Short circuit protection	Trip and restart (hiccup), auto resetting				
Patient leakage current		85	100	μA	264VAC, 60Hz

## General

Characteristic	Minimum	Typical	Maximum	Units	Notes & conditions
Efficiency	See models and ratings table				
Energy efficiency	Level VI (Level VII ready)				
Isolation: input to output input to ground	4000			VAC	2 x MOPP
	1500			VAC	1 x MOPP
Switching frequency		100		kHz	PFC converter
	20	100			Main converter (varies with load)
Power density		0.53 (8.72)		W/cm <sup>3</sup> (W/in <sup>3</sup> )	
Mean time between failure	300			khrs	TELECORDIA SR-332, 25°C, GB
Weight		290 (0.64)		g (lb)	

## Environmental

Characteristic	Minimum	Typical	Maximum	Units	Notes & conditions
Operating temperature	0		+60	°C	Derate linearly from 100% load at +40°C to 50% load at +60°C, safety approved to +40°C
Operating humidity	10		90	%RH	Non-condensing
Operating altitude			5000	m	
Storage temperature	-40		+80	°C	
Storage humidity	5		95	%RH	Non-condensing
Cooling	Natural convection				

## EMC: Emissions

Phenomenon	Standard	Test level	Notes & conditions
Conducted	EN55032/EN55011	Class B	
Radiated	EN55032/EN55011	Class B	
Harmonic current	EN61000-3-2	Class A	
Voltage flicker	EN61000-3-3		

## EMC: Immunity

Phenomenon	Standard	Test level	Criteria	Notes & conditions
ESD immunity	EN61000-4-2	4	A	±8kV contact / ±15kV air discharge
Radiated	EN61000-4-3	10V/m	A	
EFT/burst	EN61000-4-4	±2kV	A	
Surges	EN61000-4-5	2	A	±1kV line to line
Conducted	EN61000-4-6	6V	A	
Magnetic field	EN61000-4-8	30A/m	A	
Dips and interruptions	EN55035 (115VAC)	Dip:100% (0VAC), 10ms	A	
		Dip:30% (80.5VAC), 500ms	A	
		Dip:100% (0VAC), 5000ms	B	
	EN55035 (230VAC)	Dip:100% (0VAC), 10ms	A	
		Dip:30% (181VAC), 500ms	A	
		Dip:100% (0VAC), 5000ms	B	
	EN60601-1-2 (100VAC)	Dip:100% (0VAC), 10ms	A	
		Dip:100% (0VAC), 20ms	B	
		Dip:30% (70VAC), 500ms	B	
	EN60601-1-2 (240VAC)	Dip:100% (0VAC), 5000ms	B	
		Dip:100% (0VAC), 10ms	A	
		Dip:100% (0VAC), 20ms	B	
Dip:30% (168VAC), 500ms		A		
		Dip:100% (0VAC), 5000ms	B	

## Safety approvals

Safety agency	Standard	Notes & conditions
UL	UL 62368-1	Audio/video, information and communication technology equipment
	ANSI/AAMI ES60601-1	Medical
EN	EN62368-1	Audio/video, information and communication technology equipment
	EN60601-1, EN60601-1-11	Medical
CB	IEC62368-1	Audio/video, information and communication technology equipment
	IEC60601-1, IEC60601-1-11	Medical
CSA	CAN/CSA C22.2 No. 62368-1-14	Audio/video, information and communication technology equipment
	CSA C22.2 No.60601-1	Medical
CCC	China Compulsory Certification GB17625.1, GB4943.1, GB/T9254	Audio/video, information and communication technology equipment
AU/NZ	AS/NZS 62368.1	Audio/video, information and communication technology equipment
CE	Meets all applicable directives	
UKCA	Meets all applicable directives	

## Application notes

### Ambient derating

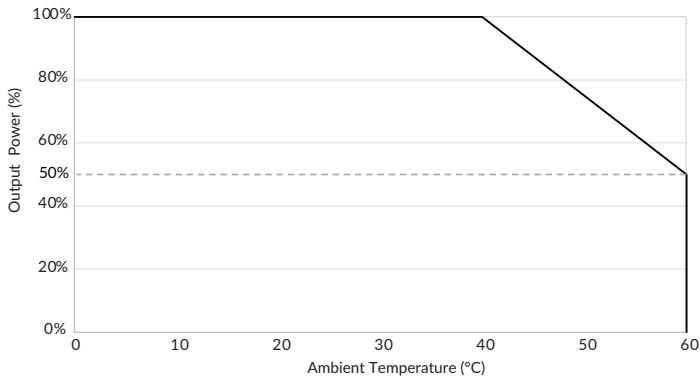

### Input derating

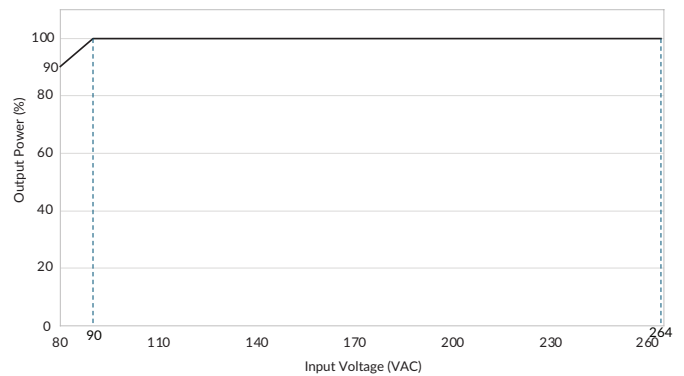

## Mechanical details

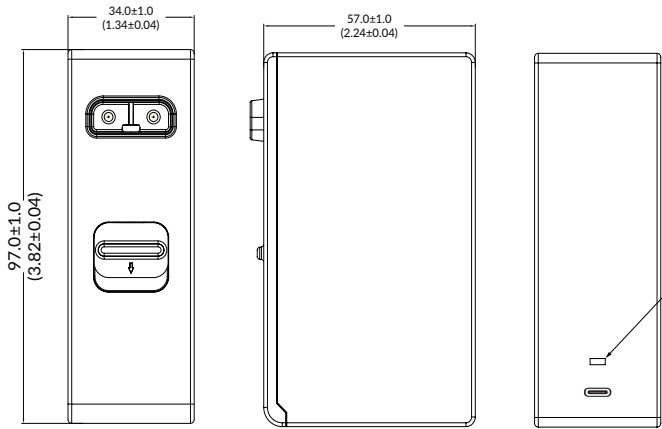

Case LED indicator	Description
Amber	Charger is connected to AC but not connected to load
Green	Charger is connected to AC and connected to load
Flashing amber	Charger is connected to AC and there is a charging fault or load faulty

Case LED indicator

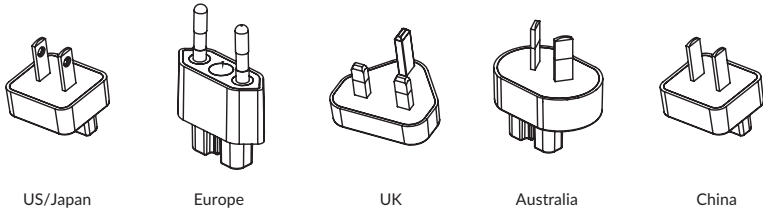
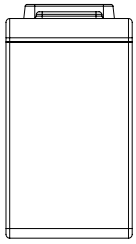

### AC input plugs

AC plug for US, to order use part number **PGW PLUG US**

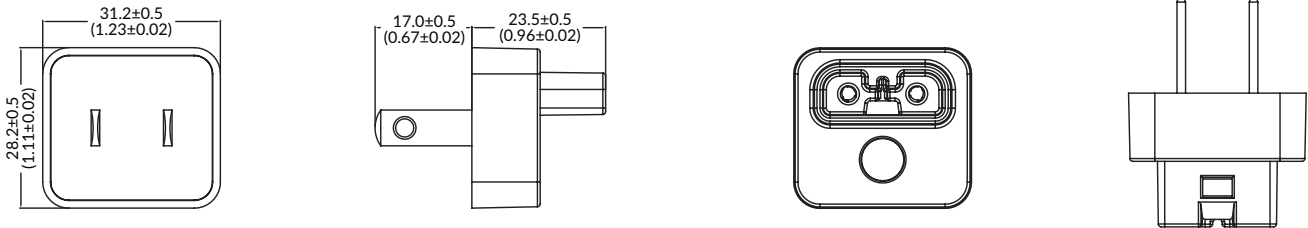

AC plug for Europe, to order use part number **PGW PLUG EU**

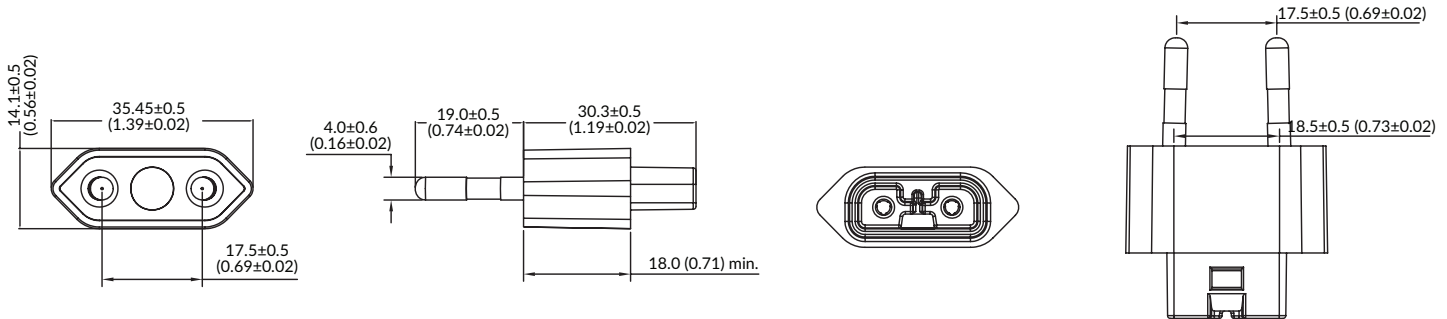

### Notes:

1. All dimensions shown in mm (inches).
2. Weight: 290g (0.64lb) approx.

3. Output connector: USB Type-C

## Mechanical details

### AC input plugs

AC plug for UK, to order use part number **PGW PLUG UK**

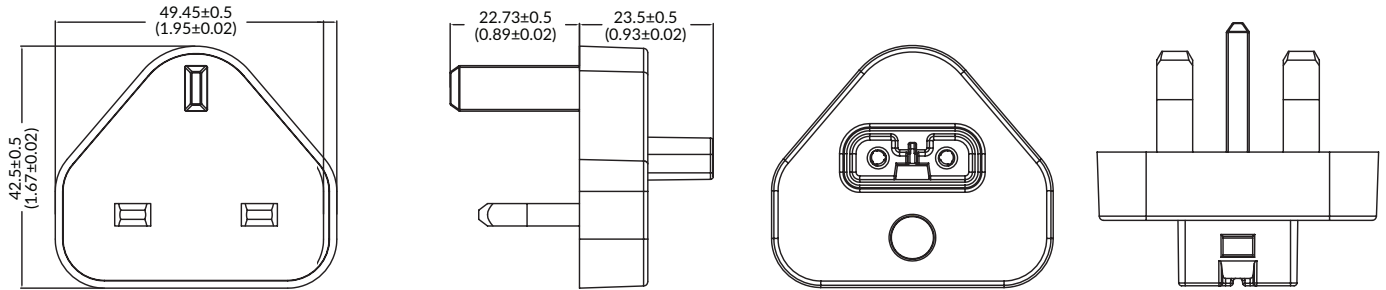

AC plug for Australia, to order use part number **PGW PLUG AU**

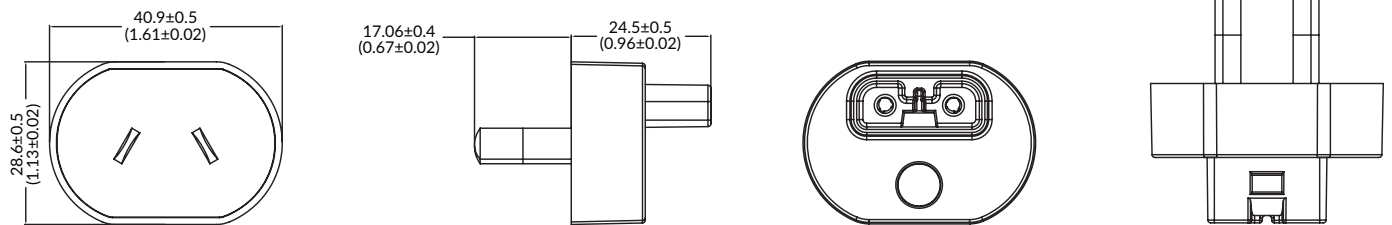

AC plug for China, to order use part number **PGW PLUG CN**

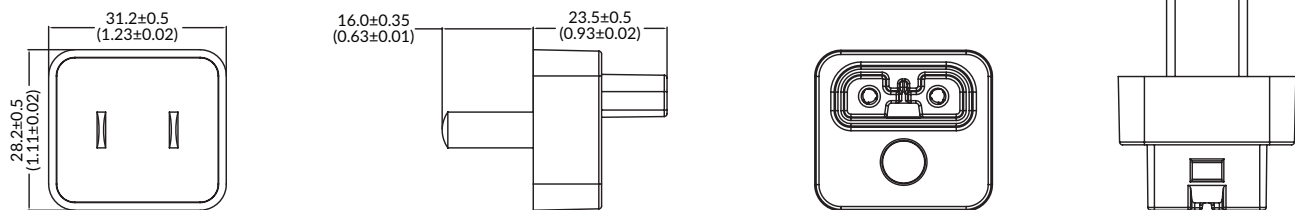

### Notes:

1. All dimensions shown in mm (inches).

Specifications subject to change without notice.