

30W

DC-DC
converters

The JHM30 series is a range of compact, regulated PCB mount medical DC-DC converters which offers single and dual output voltages ranging from 5 to 15VDC. Housed in a 50.8 x 25.4mm (2" x 1") plastic case, the JHM30 series features a 2:1 input voltage range of 9 to 18VDC, 18 to 36VDC or 36 to 75VDC and offers a $\pm 10\%$ output trim on single output versions.

The JHM30 series, with worldwide medical approvals, 2 x MOPP 4kVAC reinforced isolation and extremely low leakage currents, is specifically designed for easy integration into a wide range of BF and CF rated medical applications including imaging, patient monitoring, surgical equipment, patient treatment and dentistry.

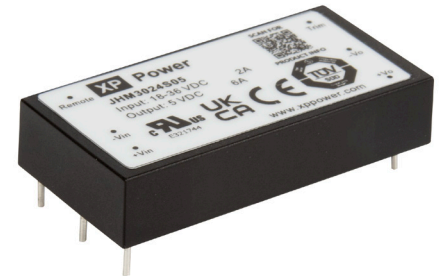

Features

- ▶ Regulated single & dual outputs from 5 to 30VDC
- ▶ 2:1 input range
- ▶ Compact 50.8 x 25.4mm (2" x 1") PCB mount package
- ▶ 10% trim on single output versions
- ▶ IEC60601-1 medical safety agency approvals
- ▶ 4kVAC reinforced isolation
- ▶ 2 x MOPP at 250VAC
- ▶ 2 μ A patient leakage current
- ▶ EN55011 class A with no external components
- ▶ Short circuit, overload & overvoltage protection
- ▶ -40°C to +80°C operating temperature
- ▶ 3 year warranty

Applications



Dimensions

50.8 x 25.4 x 10.2 mm (2.00 x 1.00 x 0.40" in)

Models & ratings

Model number	Input voltage	Output voltage	Output current	Efficiency ⁽³⁾	Input current		Maximum capacitive load ⁽²⁾
					No load ⁽¹⁾	Full load ⁽⁴⁾	
JHM3012S05	12V (9-18V)	5V	6000mA	88%	35mA	4000mA	4000µF
JHM3012S12		12V	2500mA	88%			1660µF
JHM3012S15		15V	2000mA	89%			1330µF
JHM3012D05		±5V	±3000mA	86%			±2000µF
JHM3012D12		±12V	±1250mA	88%			±800µF
JHM3012D15		±15V	±1000mA	89%			±660µF
JHM3024S05	24V (18-36V)	5V	6000mA	88%	30mA	2000mA	4000µF
JHM3024S12		12V	2500mA	88%			1660µF
JHM3024S15		15V	2000mA	89%			1330µF
JHM3024D05		±5V	±3000mA	86%			±2000µF
JHM3024D12		±12V	±1250mA	88%			±800µF
JHM3024D15		±15V	±1000mA	89%			±660µF
JHM3048S05	48V (36-75V)	5V	6000mA	88%	15mA	1000mA	4000µF
JHM3048S12		12V	2500mA	88%			1660µF
JHM3048S15		15V	2000mA	89%			1330µF
JHM3048D05		±5V	±3000mA	86%			±2000µF
JHM3048D12		±12V	±1250mA	89%			±800µF
JHM3048D15		±15V	±1000mA	89%			±660µF

Notes:

1. Input current measured at lowest input voltage.
2. Maximum capacitive load is per output.
3. Typical values at nominal input.
4. Typical values at low input voltage.

General

Characteristic	Minimum	Typical	Maximum	Units	Notes & conditions
Efficiency		88		%	See Models & ratings table
Isolation	4000			VAC	For 1 min. Double/reinforced with a working voltage of 250VAC. Meets 2 x MOPP per 3rd edition of IEC60601-1 5000VAC for 10ms in accordance with IEC60664-1
Leakage current		2		µA	
Input to output capacitance			30	pF	
Power density			63.5	W/cm ³	
Mean time between failure		>1		Mhrs	MIL-HDBK-217F, +25°C GB
Switching frequency		250		kHz	
Weight		30 (0.066)		g (lb)	
Solder profile	See Application notes				
Case material	Non conductive black plastic UL94V-0 rated				
Potting material	Silicone, UL94V-0 rated				
Pin material	Solder coated copper				

Input

Characteristic	Minimum	Typical	Maximum	Units	Notes & conditions
Input voltage range	9		18	VDC	12V nominal
	18		36		24V nominal
	36		75		48V nominal
Inrush current			70	A	Measured at maximum Input voltage
Input filter	Pi type				
Input surge			25	VDC	12V models for 3s
			50		24V models for 3s
			100		48V models for 3s
Undervoltage lockout	On at >8.2V Off <8.1V				12V models
	On at >16.8V Off <16.3V				24V models
	On at >33.2V Off <32.8V				48V models

Output

Characteristic	Minimum	Typical	Maximum	Units	Notes & conditions
Output voltage	5		30	VDC	See Models & ratings table
Output voltage trim			±10	%	Via external resistors, see Application Notes. Single output model only
Initial set accuracy			±1	%	On +Vout
			±2		On -Vout of dual output models
Minimum load	0			%	No minimum load required
Start up delay		50		ms	
Start up rise time		20		ms	
Line regulation			±0.3	%	
Load regulation			±1 / ±2	%	Single / Dual, 0-10% load
			±0.5 / ±1	%	Single / Dual, 10-100% load
Cross regulation			±4	%	On dual output models with one output set to 50% load and the other varied from 10% to 100% load (D05 20% to 100%)
Transient response deviation			4	%	Deviation recovering to within 1% in <500µs for a 25% load change at 0.25A/µs
Ripple & noise			150mV 1.5%	pk-pk	20MHz bandwidth for 5V output models 20MHz bandwidth for other models
Short circuit protection	Trip & restart (hiccup mode), auto recovery				
Maximum capacitive load	See Models & ratings table				
Temperature coefficient			0.02	%/ °C	
Overload protection	120		170	%	Trip and restart (hiccup)
Overvoltage protection	115		140		Non latching, auto recovery
Remote On/Off	On = Logic high (>3.5VDC to 12VDC) or Open Off = Logic Low (<1.2VDC)				

Environmental

Characteristic	Minimum	Typical	Maximum	Units	Notes & conditions
Operating temperature	-40		+80	°C	See derating curve
Storage temperature	-55		+100	°C	
Case temperature			+105	°C	At nominal input voltage
Humidity operating & storage	5		95	%RH	Non-condensing
Cooling	Natural convection				
Shock	±3 shocks in each plane, total 18 shocks of 30g : 11ms halfsine. Conforms to EN60068-2-27 & EN60068-2-47				
Vibration	10-500Hz at 2g sweep and endurance at resonance in all 3 planes. Conforms to EN60068-2-6				
Operating altitude			5000	m	Operating
			10,000		Storage

Safety approvals

Safety agency	Standard	Notes & conditions
UL	ANSI/AAMI ES60601-1 & CSA C22.2, No.60601-1	Medical
TUV	EN60601-1	Medical
CB	IEC60601-1	Medical
CE	Meets all applicable directives	
UKCA	Meets all applicable legislation	

Emissions - EMC

Phenomenon	Standard	Test level	Notes & conditions
Conducted	EN55011	Level A	
Radiated	EN55011	Level A	

Immunity - EMC

Phenomenon	Standard	Test level	Criteria	Notes & conditions
Immunity	IEC60601-1-2			With external components. See Application notes.
ESD immunity	EN61000-4-2	4	A	
Radiated immunity	EN61000-4-3	10V/m	A	
EFT/Burst	EN61000-4-4	3	A	
Surge	EN61000-4-5	2	A	
Conducted immunity	EN61000-4-6	10V	A	
Magnetic fields	EN61000-4-8	30A/m	A	

Mechanical details

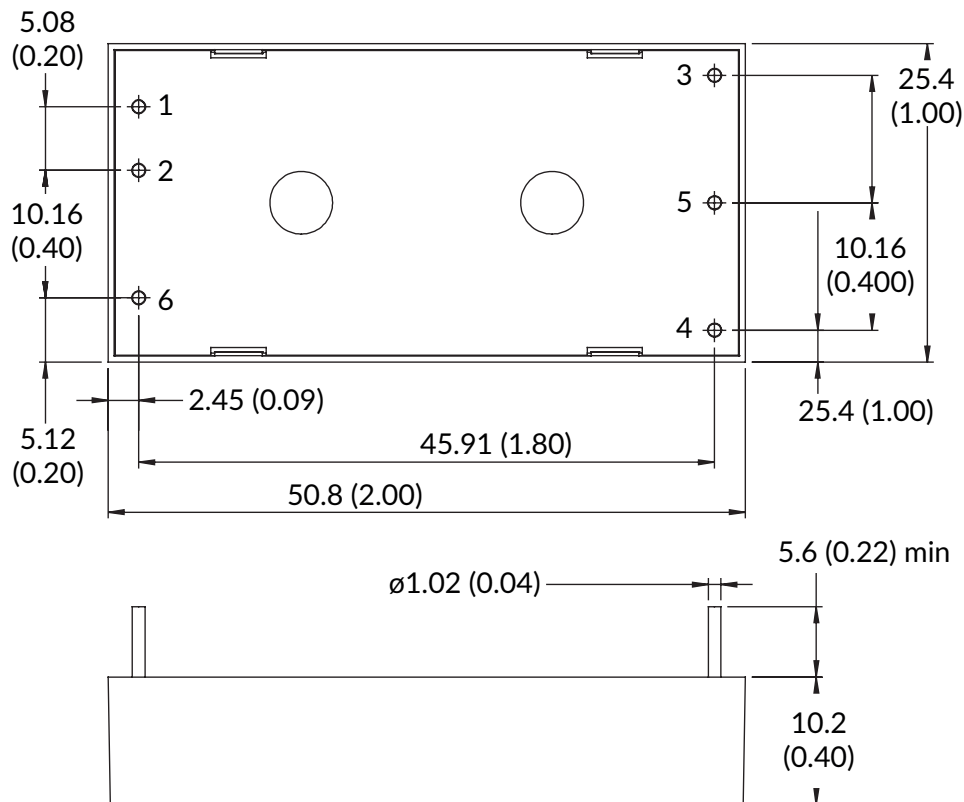

Pin connections		
Pin	Single	Dual
1	+Vin	+Vin
2	-Vin	-Vin
3	+Vout	+Vout
4	Trim	-Vout
5	-Vout	Common
6	Remote	

Notes:

1. All dimensions are in mm (inches)
2. Weight: 30g (0.066lbs) approx.
3. Pin diameter: ± 0.05 , 1.02 (± 0.002 , 0.04)

4. Pin pitch tolerance: ± 0.25 (± 0.01)
5. Case tolerance: ± 0.5 (± 0.02)

Application notes

Derating curves

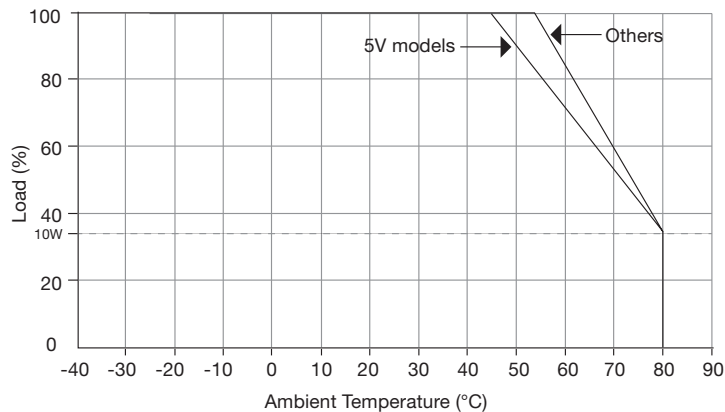

Lead free wave soldering profile

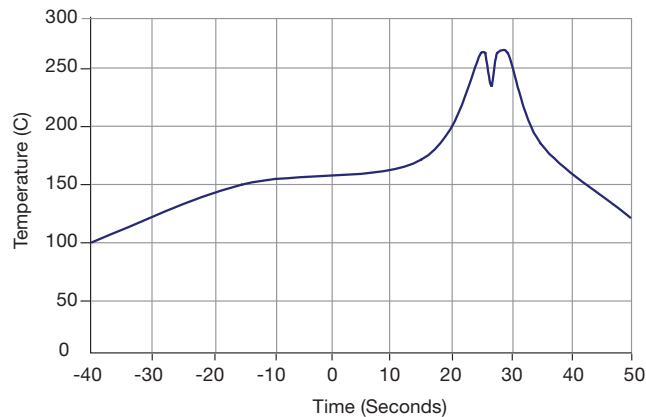

Notes:

1. Soldering Materials: Sn/Cu/Ni
2. Ramp up rate during preheat: 1.4°C/Sec (From 50°C to 100°C)
3. Soaking temperature: 0.5°C/Sec (From 100°C to 130°C), 60 ±20 seconds
4. Peak temperature: 260°C, above 250°C 3~6 Seconds
5. Ramp up rate during cooling: -10.0°C/Sec (From 260°C to 150°C)

Input fusing and safety considerations

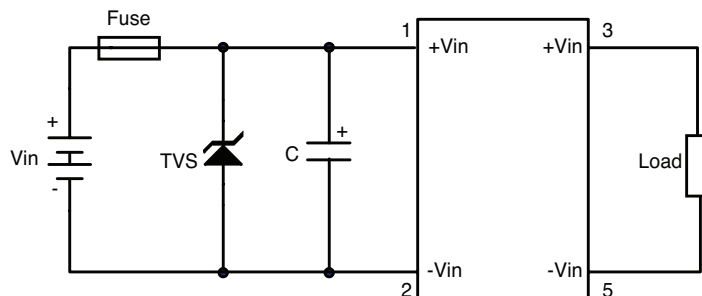

Model number	Fuse	TVS specification
JHM3012SXX	5AT	1500W 24V
JHM3024DXX	3.15A T	1500W 47V
JHM3048SXX	2AT	1500W 91V

Recommended circuit layout with time delay fuse. C = 440µF, 100V aluminium electrolytic.

Application notes

Single output voltage adjustment

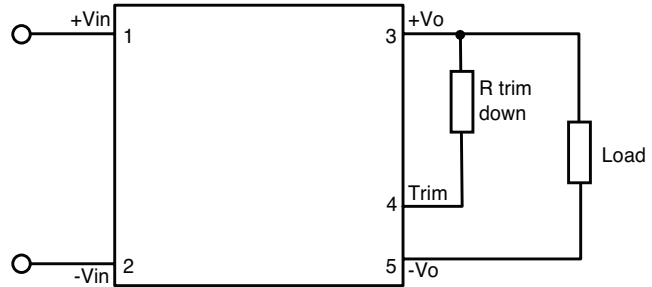
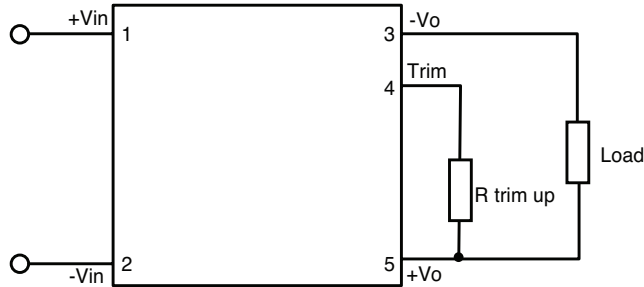

In order to trim the voltage up or down, connect the trim resistor either between the trim pin and -Vo for trim-up and between trim pin and +Vo for trim-down. The output voltage trim range is $\pm 10\%$. This is shown to the right.

The value of R trim-up defined as:

$$R_{\text{trim-up}} = \left(\frac{V_r \times R_1 \times (R_2 + R_3)}{(V_o - V_o \text{ nom}) \times R_2} \right) - R_t \text{ (k}\Omega\text{)}$$

Where:

R trim-up is the external resistor in Kohm.

Vo nom is the nominal output voltage.

Vo is the desired output voltage.

R1, Rt, R2, R3 and Vr are internal to the unit and are defined in the table to the below.

Model number	Output voltage (V)	R1 (k Ω)	R2 (k Ω)	R3 (k Ω)	Rt (k Ω)	Vr (V)
JHM3012S05	5.0	2.32	2.32	0	8.20	2.50
JHM3024S05						
JHM3048S05						
JHM3012S12	12.0	6.80	2.40	2.32	8.20	2.50
JHM3024S12						
JHM3048S12						
JHM3012S15	15.0	8.20	2.40	0.91	3.9	2.50
JHM3024S15						
JHM3048S15						

For example, to trim-up the output voltage of 5.0V module (JHM3012S05) by 10% to 5.5V, R trim-up is calculated as follows:

$$V_o - V_o \text{ nom} = 5.5 - 5.0 = 0.5V$$

$$R_1 = 2.32k\Omega$$

$$R_2 = 2.32k\Omega$$

$$R_3 = 0k\Omega$$

$$R_t = 8.2k\Omega, V_r = 2.5V$$

$$R_{\text{trim-up}} = \left(\frac{2.5 \times 2.32 \times (2.32 + 0)}{(5.0 - 5.0) \times 2.32} \right) - 8.2 = 3.4 \text{ (k}\Omega\text{)}$$

The value of R trim-down defined as:

$$R_{\text{trim-down}} = R_1 \times \left(\frac{V_r \times R_1}{(V_o - V_o \text{ nom}) \times R_2} - 1 \right) - R_t \text{ (k}\Omega\text{)}$$

Where:

R trim-down is the external resistor in Kohm.

Vo nom is the nominal output voltage.

Vo is the desired output voltage.

R1, Rt, R2, R3 and Vr are internal to the unit and are defined in the table to the above.

R1, Rt, R2, R3 and Vr are internal to the unit and are defined in the above table.

For example, to trim-down the output voltage of 5.0V module (JHM3012S05) by 10% to 4.5V, R trim-down is calculated as follows:

$$V_o \text{ nom} - V_o = 5.0 - 4.5 = 0.5V$$

$$R_1 = 2.32k\Omega, R_2 = 2.32k\Omega, R_3 = 0k\Omega$$

$$R_t = 8.2k\Omega, V_r = 2.5V$$