

ESB00163 16A

ESB00323 32A

200/400/500Vac 3-phase Inrush Current Limiter for Capacitive Loads

Short Specification:

- Peak- / R.M.S. current limiter
- 200/400/500Vac 3ph 16A/32A
- DIN TS35mm DIN-Rail
- Wall mount (universal housing)
- Spring-type terminals 16mm² / 22-8AWG
- Integrated bypass relay
- Capacitive load 2.000uF
- Integrated over temperature protection.
- EN62368-1, EN55032 class B

The ESB00163 and the ESB00323 are industrial rated peak current inrush limiters for high loads in LED-applications, complex automation systems and in the machine building. The ESB offers effective and interference free operation with capacitive loads. The ESB is self- powering and does not require an external power supply. The units feature an integrated phase controller. It allows to monitor each AC line independent from each other. Also, each AC line is being limited independent from each other.

The ESB is no simple NTC solution. The units allow precise accurate repeatable limiting of the peak inrush. The ESBs protect the installed circuit breakers from tripping accordingly.



ESB00163(R2)/ESB00323(R2) MANUAL

Technical Table				
Product Code	ESB00163A(R2)	ESB00163B(R2)	ESB00323A(R2)	ESB00323B(R2)
Article Number	3041099011	3041099001	3041099012	3041099002
AC Input Range	170-230/340-460/ 425-575Vac	170-230/340-460Vac	170-230/340-460/ 425-575Vac	170-230/340-460Vac
AC Nominal Voltage	200/400Vac/500Vac	200/400Vac	200/400/500Vac	200/400Vac
Ambient Temperature	-40°C ... +55°C continuous	-40°C ... +70°C continuous	-40°C ... +55°C continuous	-40°C ... +70°C continuous
Derating	+45°C 2,5%/°C	+60°C 2,5%/°C	+45°C 2,5%/°C	+60°C 2,5%/°C
Peak Current Limiting ±6%	22,6A		68,6A	
R.M.S Current Limiting	16A ±6%		48A ±6%	
Max. Capacitive Load	1.500µF		2.000µF	
Limiting Time (T _{on} Power On)	70-240ms adjustable (150ms Factory Setting) Tolerance ±10ms		70-240ms adjustable (150ms Factory Setting) Tolerance ±10ms	
Release Time (T _{off} Low Voltage)	65-170 adjustable (100ms Factory Setting) Tolerance ±10ms		65-170 adjustable (100ms Factory Setting) Tolerance ±10ms	
Limiting Interval	≥ 1000ms (T _{interval} for AC _{cont.})		≥ 1000ms (T _{interval} for AC _{cont.})	
Smallest MCB at 30°C	8A Curve A, 6A Curve B, 8A Curve Z		22A Curve A, 16A Curve B, 22A Curve Z	
Largest MCB allowed	16A		32A	
Line Frequency	50/60Hz		50/60Hz	
AC Continuous Current	16A continuous		32A continuous	
Power Supply	self-powered			
Power Consumption	typ. 7W (constant @ nominal operation)			
Limiting Cycles	1 cycle/minute with maximum capacitive load (see above)			
Internal Protection	temperature protection and burn proof fuse in each AC-line			
Cooling	natural convection			
Operation Temp.	nominal ambient temperature -40°C ... +70°C			
Storage Temp.	-40°C ... +85°C 2 years			
ROHS	2011/65/EU, (EU)2015/863			
REACH	EG No. 1907/2006			
EMI	EN55032 class B, EN61000-6-3			
EMS	EN61000-6-2			
Safety Norms	EN61010-1, EN6101-2-201, EN62368-1 (with ≤3x420Vac), EN60950-1, EN60204-1			
Protection Class I	PE connection required			
MTBF Calculation	377.000h (IEC/EN61709, Siemens SN29500)			
MTTF Calculation	396.000h (+30°C) (IEC/EN61709, Siemens SN29500)			
Humidity	95% (+25°C) not condensing			
Pollution Degree	2 (IEC/EN50178)			
Environmental	climatic 3K3, mechanics 3M4 (IEC/EN60721)			
Altitude max.	3000m (9842 ft.) above sea level			
Dimension (WxHxD)	95x155x122mm			
Housing Parameters	aluminum metal housing			
DIN-Rail	DIN rail TS35mm DIN/EN60715 (TS35/7,5 und TS35/15)			
Weight	1100g			
Connections	spring-type terminal with cable protection 0,5...16mm ² 22...8AWG in accordance with IEC/EN60664-1, IEC/EN61984			

General Description

The ESB00163 and ESB00323 are the 3rd generation industrial rated inrush current limiter. The limiter is designed for 200/400/500Vac 3-phase networks L1/L2/L3/PE. The PE conductor must not be connected to the ESB. The line frequency range is 16½Hz – 440Hz. The ESB-Limiter shall be located between the line-switcher/contactors and the load. The ESB is designed for capacitive loads, only. The ESBs cannot be used together with transformers, coils, AC-motors & drives, heaters, ohmic load, or with DC-voltage at all. In the moment of switching-on the system the inrush current of the installed load will be limited for the defined time T_{on}. Independent from the previous inrush level; the current limiting is always strict. After T_{on} elapses the current limiting circuit of the ESBs will be bypassed. Then the load is directly connected to the AC. If an AC dump overshoots the defined time T_{off}, it will be detected by the ESBs. As soon as the AC recovers the inrush will be limited, again. The ESB-models provide an internal temperature control. In case of a failure the devices shut down to safely prevent from overheating or fire.

ESB00163(R2)/ESB00323(R2) MANUAL

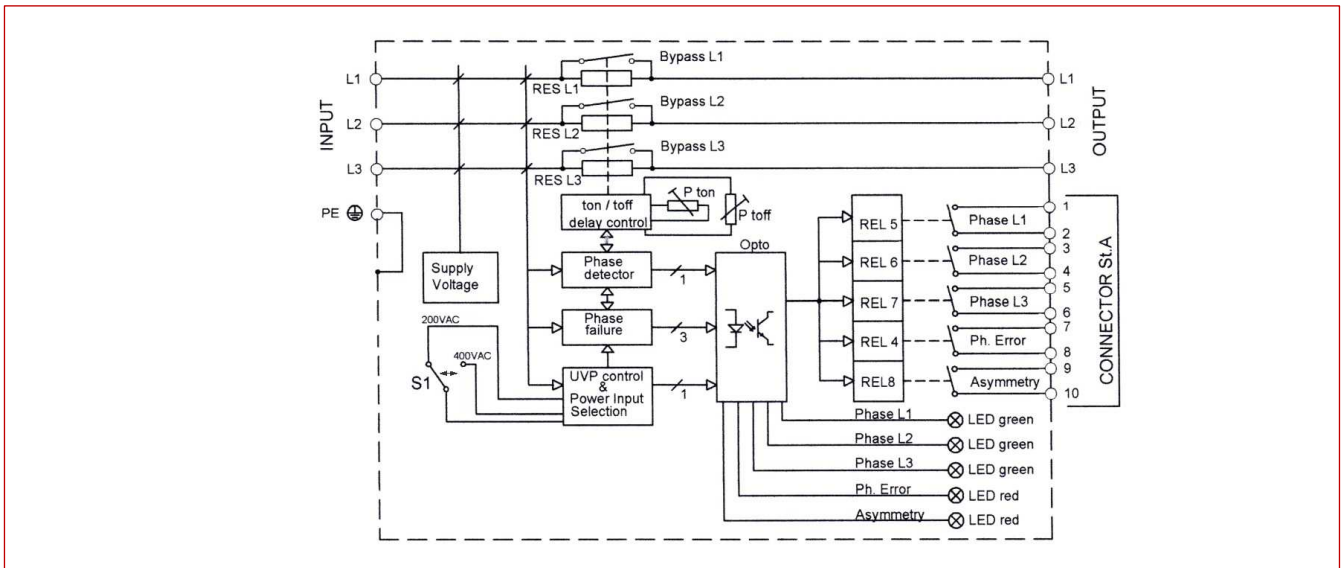

Field Applications

The ESB00163 and ESB00323 are designed for 3-phase capacitive load, such as switch mode power supplies. The limiters allow connecting much more capacitive loads to a pre-installed circuit breaker CB. The ESB avoids that the MCB will be tripped. This occurs independent to the objective initial current. The result is that the number of A.C. branch lines and the pre-installed MCB can be reduced dramatically. Installation costs exhibit a sustained decline. Alternatively, the cross section of the branch lines can be reduced when using smaller and faster responding circuit breakers. The cost saving from copper is essential. Sensitive AC networks can be fused safer (e.g. Traffic Control Systems, industrial machines, industrial plants, and Tunnels). The load relates to the AC in such a way that a circuit breaker or an earth-leakage-trip works within the limits of the legal rules. This fact is also applied while the limiting circuit acts. The ESBs are designed for capacitive loads, only. The ESBs cannot be used together with transformers, coils, AC-motors & drives, heaters or with DC-voltage at all.

Phase Monitoring

The ESB00163 and the ESB00323 ESBs has an integrated phase control circuit with basic functionality. Each phase is controlled separately. Each phase is limited separately. The error messages some separately for each phase. The signals allow to display complex and interlinked failures in a major control room. The different signaled failures will be described on page in this manual.

Signal Output Table

PIN	CTRL	O.K.	LED	FAILURE	LED
1,2	L1	Relais closed	ON	Relais open	OFF
3,4	L2	Relais closed	ON	Relais open	OFF
5,6	L3	Relais closed	ON	Relais open	OFF
7,8	Phase Error	Relais closed	OFF	Relais open	ON
9,10	Asymmetry	Relais closed	OFF	Relais open	ON

Line Inputs

PE = GND
L1 = Phase 1
L2 = Phase 2
L3 = Phase 3

Line Outputs

L1 = Phase 1
L2 = Phase 2
L3 = Phase 3

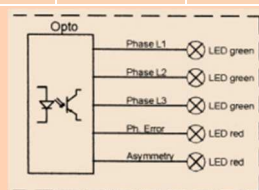

AC Input Selector Settings

ESB00163A.T / ESB00323A.T	ESB00163B.T / ESB00323B.T
1 = 200Vac	1 = 200Vac
2 = 400Vac	2 = not selectable
3 = 500Vac	3 = 400Vac

WARNING

The input selector enables to set the AC Input voltage auf the models. It is located above the phase error Connection. Please make sure that the input is set to the correct AC voltage before taking the device into operation. A wrong setting may cause serious damages to the device!



ESB00163(R2)/ESB00323(R2) MANUAL

Phase Monitoring to SPC

The signals "Phase-Error" and "Asymmetry-Error" can be used to trigger an external contactor. The installed load will be disconnected if an error occurs. As soon as the error recovers the installed load will be reconnected to the AC. (find attached pictures Phase-Loss, Phase-sequence, Asymmetry, Over-Voltage and Low-Voltage. The contactor is always named K2.)

Phase Loss & Sequence

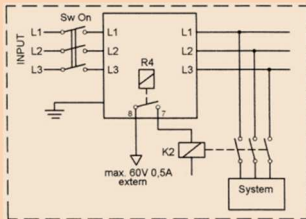

In case of phase loss relay 4 opens after a delay time of 30ms. Synchronic the relay of the appropriate phase opens, too and its green LED extinguishes. When the phase sequence is incorrect, relay 4 opens after a delay time of 30ms. The Phase Error LED lights red. When the phase sequence is correct the LED is off and the relay 4 is closed.

Asymmetry, Over-/Low Voltage

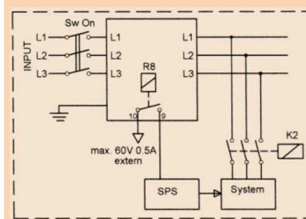

The asymmetry monitoring detects a voltage difference of the three phases to each other. This kind of measuring enables work without the N line (four wire system). If the voltage of the measured AC line drops or exceeds 15% of its nominal selected input relay 8 opens 8-10s delayed and the Asymmetry LED lights red. Measuring tolerances are $\pm 2\%$.

Phase Loss Message Block

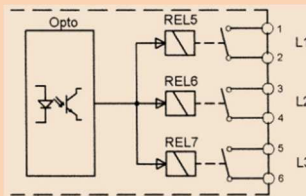

Relay 5 to 7 are galvanic insulated via opto-couplers. If L1 to L3 are operating the relays are closed. If one phase drops its relay opens and the message can be used with an active signal (60V/500mA maximum load each relay).

Monitoring L1

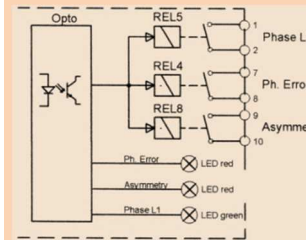

Phase Monitoring L1 O.K.:
REL4,5 closed, LED green on
Phase Error LED red off

Phase Monitoring L1 Loss:
REL4,5 open, LED green off
Phase Error LED red on
Asymmetry REL8 remain closed, LED off

Phase Sequence Monitoring

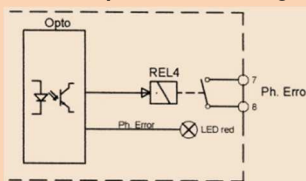

Sequence o.k.:
L1, L2, L3 o.k. REL4 closed
Phase Error LED red off

Phase Reversal:
L1 failure
L2 o.k.
L3 failure (sum failure)
REL4 open
Phase Error LED red on

Monitoring L2

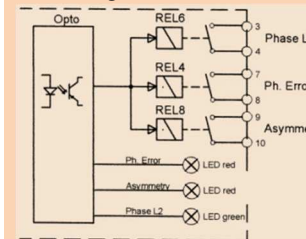

Phase Monitoring L2 O.K.:
REL4,6 closed, LED green on
Phase Error LED red off

Phase Monitoring L2 Loss:
REL4,6 open, LED green off
Phase Error LED red on
Asymmetry REL8 remain closed, LED off

Asymmetry, Over-/Low Voltage

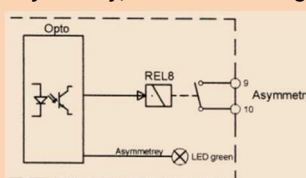

Low Voltage o.k.:
L1, L2, L3 sum o.k.
Asymmetry REL8 closed, LED off

Low Voltage failure (-15% drop):
L1 failure
L2 o.k.
L3 o.k. (but sum failure)
Asymmetry REL8 open, LED on

Overvoltage failure (+15% drop):
L1 failure
L2 o.k.
L3 o.k. (but sum failure)
Asymmetry REL8 open, LED on

Monitoring L3

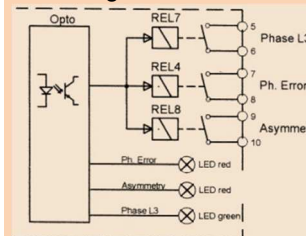

Phase Monitoring L3 O.K.:
REL4,7 closed, LED green on
Phase Error LED red off

Phase Monitoring L3 Loss:
REL4,7 open, LED green off
Phase Error LED red on
Asymmetry REL8 remain closed, LED off

ESB00163(R2)/ESB00323(R2) MANUAL

Line Diagram of the Phase Monitoring

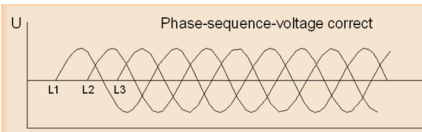

Sequence, Voltage and Asymmetry are o.k.:

No Failure:

All LEDs of L1, L2, L3 light green, all relays are closed, and all red Error LED are off

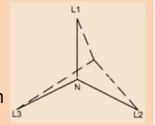

Asymmetry in AC line 4 Wire Systems (no N wire): Dissimilar phase load exists, when one phase is overloaded in comparison to the other phases of the 4 Wire System.

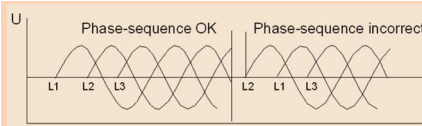

Sequence Monitoring:

Failure

Relay4 (Phase Error) opens after 30ms delay time and its error LED lights red

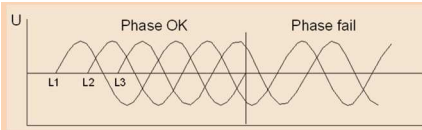

Phase Loss:

Failure

Relay4 (Phase Error) opens after 30ms delay time and its error LED lights red, belonging phase LEDs are off and its relays are open

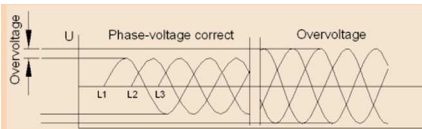

Low Voltage, Overvoltage and Asymmetry:

Failure

If voltage under-runs or exceeds $\pm 15\%$ of the selected rated voltage, Relay8 (Asymmetry) opens after 8-10s delay time and its error LED lights red

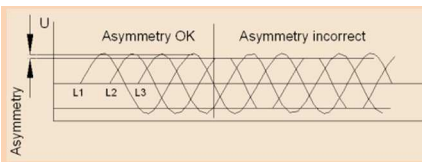

Rated Voltage

200Vac

400Vac

Low Voltage Operating Point

170Vac

340Vac

Over Voltage Operating point

230Vac

460Vac

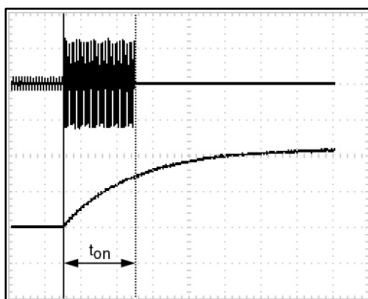

(Fig.5 limiting time T_{on})

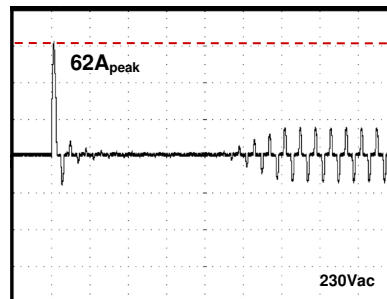

(Fig.7 inrush without an ESB)

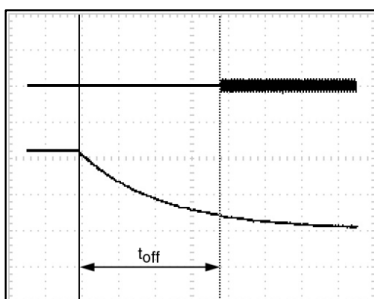

(Fig.6 AC dump detection T_{off})

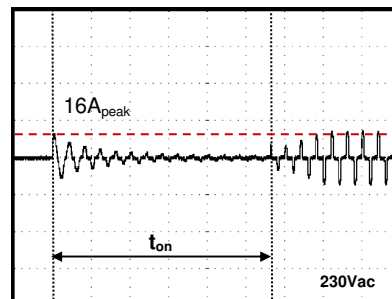

(Fig.8 inrush with an ESB)

Fig.7 and Fig.8

Fig.7 and Fig.8 show the typical start behavior of a NTC protected 3-phase switch mode power supply. The example looks at the ESB00163 model.

The peak current recordings show the precise limiting of the inrush from formerly $62A_{peak}$ to $16A_{peak}$. The corresponding R.M.S level, that is responsible for the magnetic tripping of the CB, is mark down by factor 0,707. After the time T_{on} elapsed it is identified that the power supply starts neatly into the continuous operation mode.

Now the current is absorbed pulse-shaped from the AC.

ESB00163(R2)/ESB00323(R2) MANUAL

Design-In of the ESB into A/C networks

The ESB00163 and ESB00323 models are precision inrush current limiters with an overall tolerance of $\pm 6\%$ of the face value. For the dimension of an upstream connected circuit breaker the R.M.S is the key value of the inrush current, not the peak current. The thermal trigger point will not be met, even while using an extreme fast CB. All-dominant is the magnetic trigger current. By using the empirical formula, $I_{(peak)} \times 0,707_{(factor)} = I_{(r.m.s.)}$ the tripping current can be defined exact. Bear in mind that all the higher the inrush current is, all the faster the input capacitor of several connected switch mode power supplies will be loaded. Do not use an MCBs larger than the rated current of the ESB device

Ton / Toff adjust

The Ton-time (limiting period) and the Toff-time (response time to arm the circuit after a phase lost or voltage drop) can be adjusted by the owner. The factory settings are Ton=150ms and Toff=100ms.

Note: the adjusting range is non-linear.

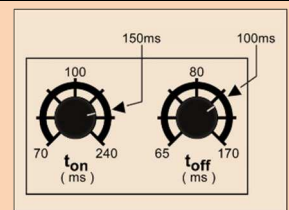

Mechanics & Installation Instruction of the ESB00163 & ESB00323

Stable metal/aluminium housing IP20. To allow adequate convection, a free air space of 50mm (top/bottom) and 10mm (sidewalls) is required; and for active devices 15mm space from the sidewalls.

One can use the DIN-Rail installation (equipped standard) with our patented 35mm DIN-Rail bracket according to EN60715. It is easy to mount/dismount while snapping it onto the 35mm DIN-Rail - no tools necessary.

It is not allowed to install the ESB in other mounting direction then below drawings.

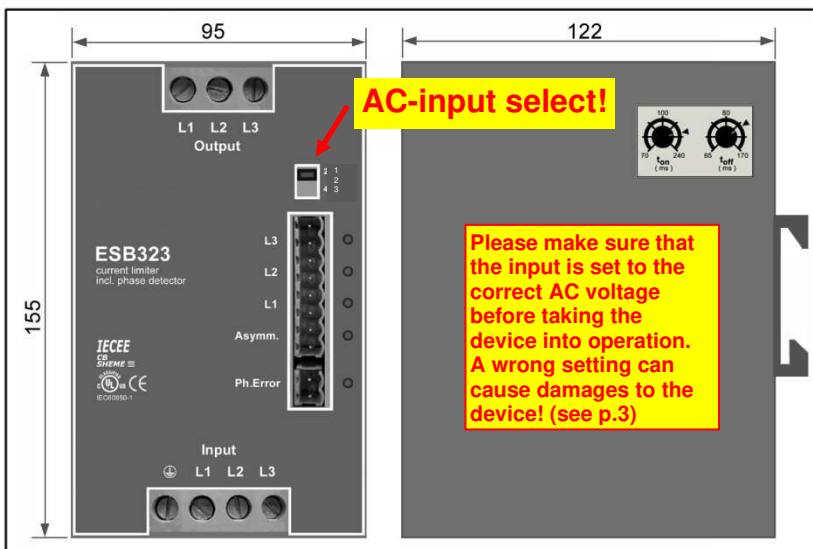

(picture 9 mechanical dimensions)

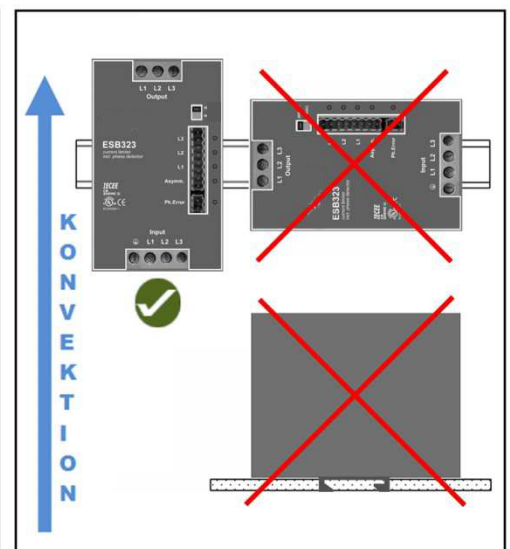

(picture 10 mounting direction)

ESB00163(R2)/ESB00323(R2) MANUAL

Electrical Safety (Factory-Test / Field-Test Owner)

	T	A	B	C
Type Test	60s	2500Vac	3000Vac	500Vdc
Factory Test	5s	2500Vac	2000Vac	500Vdc
Field Test	2s	2500Vac	2000Vac	500Vdc
Cut-off current setting	>5mA	>5mA	>5mA	>1mA

Type and factory test are the manufacturer. While repeating damage can happen to the unit. For the field test (owner) follow the below instruction:

- Use suitable test equipment, raising the voltage slowly
- For every Test L1, L2, L3 at the input and at the output must be connected, Earth needs always to be connected.
- Use only test voltages of 50/60Hz. The outputs are unearthed and therefore they have no resistance to GND/PE.

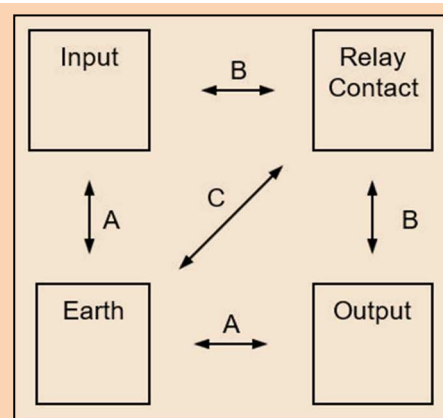

Safety Instructions:

Please read all warnings and advice carefully before installing or operating the ESB. Retain this operation manual always ready to hand. The ESB must be installed by specialist staff only.

Installation:

- Before connecting the ESB to the AC wire system make all wires free of voltage and assure accidentally switch on
- Before installing the ESB switch S1 to the appropriate AC input voltage (200/400Vac 50Hz).
- Connect the ESB inputs and Outputs to the AC line system. Assure that the phase sequence is correct.
- Switching the AC line system on immediately starts running the ESB. Ton limiting time elapses. The control LEDs of L1, L2, L3 should light green, the red LEDs of the Phase Error and the Asymmetry should be off. All relay contacts of the monitoring outputs are closed.
- In case of any control LEDs do not light like described in step 4, switch off the AC wire system and check your cabling.
- Note:** The device must not be operated without an upstream circuit breaker (CB). Never use a type with larger current than the rated current of the connected ESB. It is prohibited to use the unit without PE. It may be necessary upstream device has a power switch.

Warnings:

Disregard these warnings can cause fire, electric shock, serious accident, and death.

- Never operate the ESB without Protective Earth
- Before connecting the ESB to the AC make all wires free of voltage and assure accidentally switch on
- Allow neat and professional cabling.
- Never open nor try to repair the ESB by yourself. Inside are dangerous voltages that can cause electric shock.
- Avoid metal pieces or any material to fall into the ESB.
- Do not operate the ESB und damp or wet conditions.
- The ESB must not be operated under Ex conditions or in Ex area

