

AC-DC Converter

**POWER
SOLVE**

PAK1500 Series 1500W Active PFC Single Output

www.powersolve.com.tw

Features

- Universal AC Input with active PFC
- Programmable Output Voltage (30%-105%)
- Programmable Output Current (40%-105%)
- High Efficiency up to 90%
- +5V/0.5A Auxiliary Output
- Intelligent LED Indicators
- 1.5U profile, High Power Density
- Forced current sharing for parallel operation
- Power OK signal (Power good, logic low)
- Remote ON/OFF, Remote Sense function
- OVP, OLP, OTP, SCP, Fan Failure Protections



Electrical Specification

Input Voltage	90-264VAC, 47-63Hz / 127-370VDC. Below 100VAC, derate load linearly to 90% at 90VAC
Power Factor	EN61000-3-2 (0.98 at 230VAC / 0.99 at 115VAC at full load)
AC Input Current (typ.)	18A at 115VAC / 9A at 230VAC
Inrush Current	30A at 115VAC / 45A at 230VAC
Leakage Current	<2.5mA at 240VAC
Output Voltage	See Table
Output Current	See Table
Voltage Tolerance	±1%
Voltage Adjust Range	±5.0% typical adjustment by potentiometer
Overload Protection	105-110% of rated output power. Constant I Limiting, output latches off, recycle AC input to recover
Overvoltage Protection	Variable OVP, 120% ±5% of Vout. Output latches off, recycle AC input to recover
Over Temperature Protection	80±5°C. Shuts down output, recovers automatically when temperature goes down
Auxiliary Power	+5V @ 0.5A (±3%)
Remote ON/OFF Control	External switch or NPN transistor to turn on/off
Power OK Signal	Open drain signal low when PSU turns on. Max. sink current 20mA, max. drain voltage 40V
Output Voltage Programming	Adjustment of output voltage between 30-105% of rated output (see graph)
Output Current Programming	Adjustment of output current between 40-105% of rated output (see graph)
Operating Temperature Range	-25°C to +60°C. Above 30°C, derate linearly to 70% load at 60°C
Operating Humidity	20-90% RH non-condensing
Storage Temperature Range	-40°C to +85°C
Storage Humidity	10-95% RH non-condensing
Temperature Coefficient	±0.02%/°C (0-50°C)
Vibration	Compliance to IEC 68-2-6, IEC 68-2-64
Safety Standards	UL60950-1 2nd edition, TUV EN60950-1: 2006+A11 Approved
Withstand Voltage	I/P-O/P: 3KVAC, I/P-FG: 1.5KVAC, O/P-FG: 0.5KVAC
Isolation Resistance	I/P-O/P, I/P-FG, O/P-FG: 100MΩ / 500VDC
EMI Conduction & Radiation	EN55022: 2006 Class B
Harmonic Current	EN61000-3-2: 2006 Class A, EN61000-3-3: 1995+A1: 2001+A2: 2005
EMS Immunity	EN61204-3: 2000, EN55024: 1998+A1: 2001+A2: 2003 light industry level, criteria A
Cooling	Controlled by power rating & temperature (internal fan). Ensure 50mm free space at each end.
Dimensions	280(L) x 127(W) x 63.5(H) mm
Weight	3.2Kg

Notes:

1. All parameters NOT specifically mentioned are measured at 230Vac input, rated load and 25°C ambient temperature
2. Ripple and noise are measured at 20MHz bandwidth by using a 12" twisted pair wire terminated with a 0.1μF ceramic & 47μF electrolytic capacitors across the output
3. Derating is required at low input voltages. Below 100Vac, derate linearly to 90% load at 90Vac
4. When parallel connected, only one unit may operate if the total output load is less than 5% of rated load
5. The power supply is considered a component which will be installed into a final equipment. The final equipment must be re-confirmed that it still meets EMC Directives

Email: sales@powersolve.com.tw

AC-DC Converter



www.powersolve.com.tw

Output Voltage and Current Ratings

MODEL	OUTPUT VOLTAGE	MAX OUTPUT CURRENT	RIPPLE & NOISE	LINE REG.	LOAD REG.	POWER Max.	EFF.
PAK1500-12	12V	125A	150mV p-p	±0.5%	±1.0%	1500W	87%
PAK1500-15	15V	100A	150mV p-p	±0.5%	±1.0%	1500W	88%
PAK1500-24	24V	62.5A	150mV p-p	±0.5%	±1.0%	1500W	89%
PAK1500-27	27V	55.5A	150mV p-p	±0.5%	±1.0%	1500W	89%
PAK1500-48	48V	31.3A	150mV p-p	±0.5%	±1.0%	1500W	90%

Mechanical Details

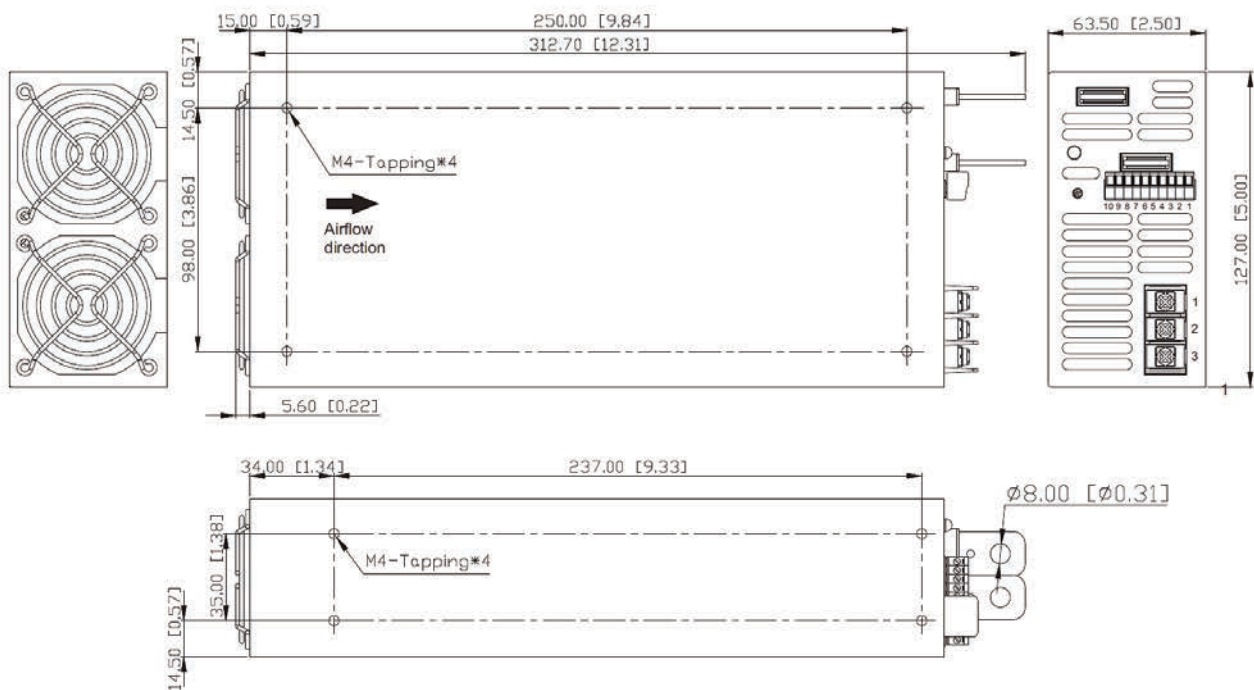

Connection Details

Input Connector

Pin No.	Function	Description
1	ACL	Live
2	ACN	Neutral
3	PE	Earth

Control Connector

Pin No.	Function	Description
1	VS+	Remote Voltage Sense (+)
2	VS-	Remote Voltage Sense (-)
3	Aux	+5V / 0.5A Auxiliary Power
4	EN+	Remote ON/OFF (+)
5	EN-	Remote ON/OFF (-)
6	GND	Ground
7	POK	Power OK
8	VCI	V Program
9	ACI	I Program
10	PAR	Parallel Operation Current Share

AC-DC Converter



www.powersolve.com.tw

LED Status		
LED Colour	LED Signal	Status
Green LED	Solid	Power OK
	Slow Blink	Power Standby
	Fast Blink	Over Voltage Protection (OVP)
Red LED	Solid	Over Load Protection (OLP)
	Slow Blink	Output Short Circuit Protection (SCP)
	Intermittent Blink	Under Voltage Protection (UVP)
	Interlace Blink	Over Temperature Protection (OTP)
	Intermittent Blink	Fan Failure
	Interlace Blink	Power Failure

Remote ON/OFF

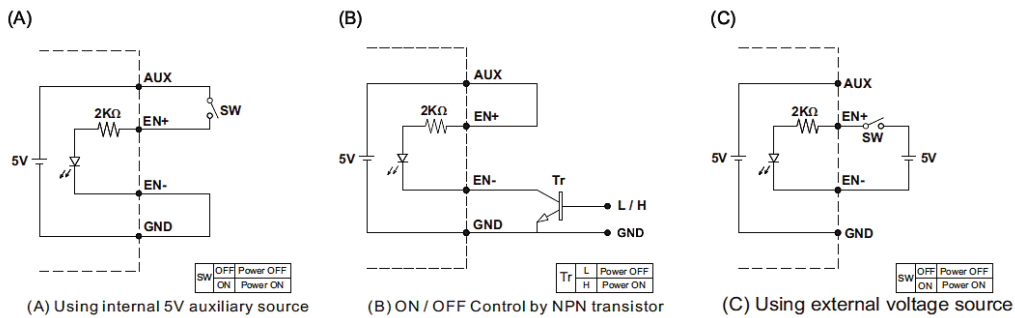

Derating Curve

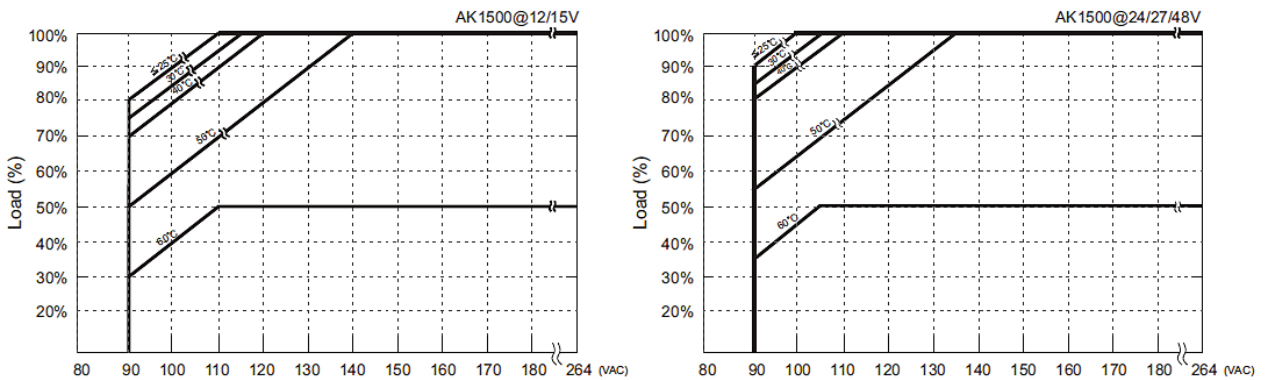

AC-DC Converter



www.powersolve.com.tw

Output Voltage & Current Program

Output Voltage Program

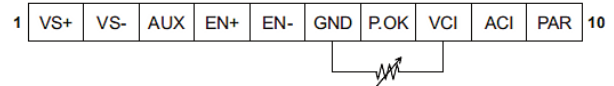
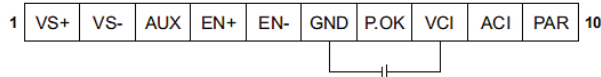
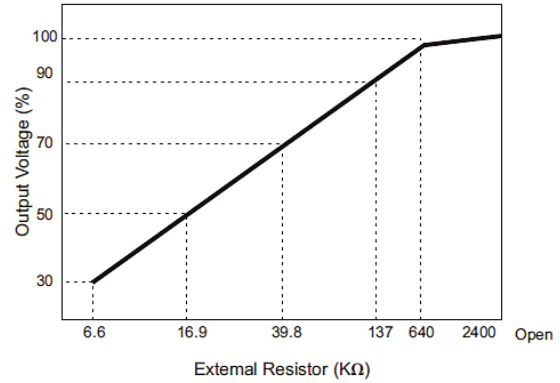
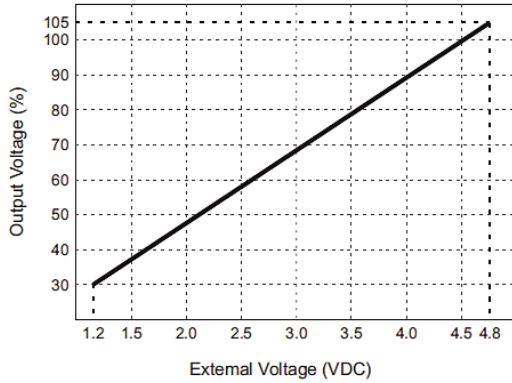

Output Current Program

